

447FZ-KZ447

MONORACK SPECIFICO - SPECIFIC MONORACK  
MONORACK SPECIFIQUE - SPEZIFISCHES MONORACK - MONORACK ESPECÍFICO

# KAWASAKI VERSYS

## 650cc

ISTRUZIONI DI MONTAGGIO - MOUNTING INSTRUCTIONS  
INSTRUCTIONS DE MONTAGE - BAUANLEITUNG - INSTRUCCIONES DE MONTAJE

①



**SUPPORTO**  
SUPPORT  
SUPPORT  
HALTERUNG  
SOPORTE

**Q.TY n.2(Dx-Sx)**

②



**SUPPORTO**  
SUPPORT  
SUPPORT  
HALTERUNG  
SOPORTE

**Q.TY n.2(Dx-Sx)**

③



**SUPPORTO**  
SUPPORT  
SUPPORT  
HALTERUNG  
SOPORTE

**Q.TY n.2(Dx-Sx)**

④



**MOUSSE PROTETTIVA**  
Z1639DX e Z1639SX  
PROTECTIVE RUBBER PADS  
MOUSSE DE PROTECTION  
SCHUTZGUMMI  
ESPUMA ADHESIVA  
PROTECTORA

**Q.TY n.2**

⑤



**VITE TCEI M8x25mm**  
Nere  
SCREW M8x25mm  
VIS M8x25mm  
SCHRAUBE M8x25mm  
TORNILLO M8x25mm

**Q.TY n.2**

⑥



**VITE TE M8x20mm**  
Flangiate Nere  
SCREW M8x20mm  
VIS M8x20mm  
SCHRAUBE M8x20mm  
TORNILLO M8x20mm

**Q.TY n.2**

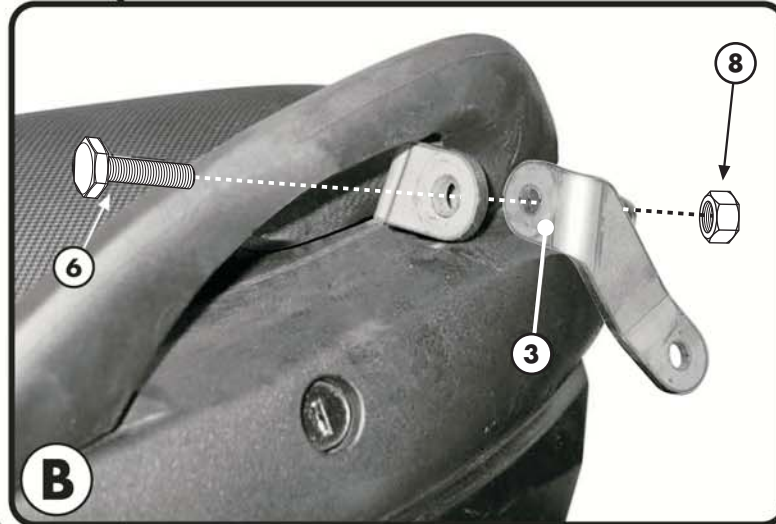
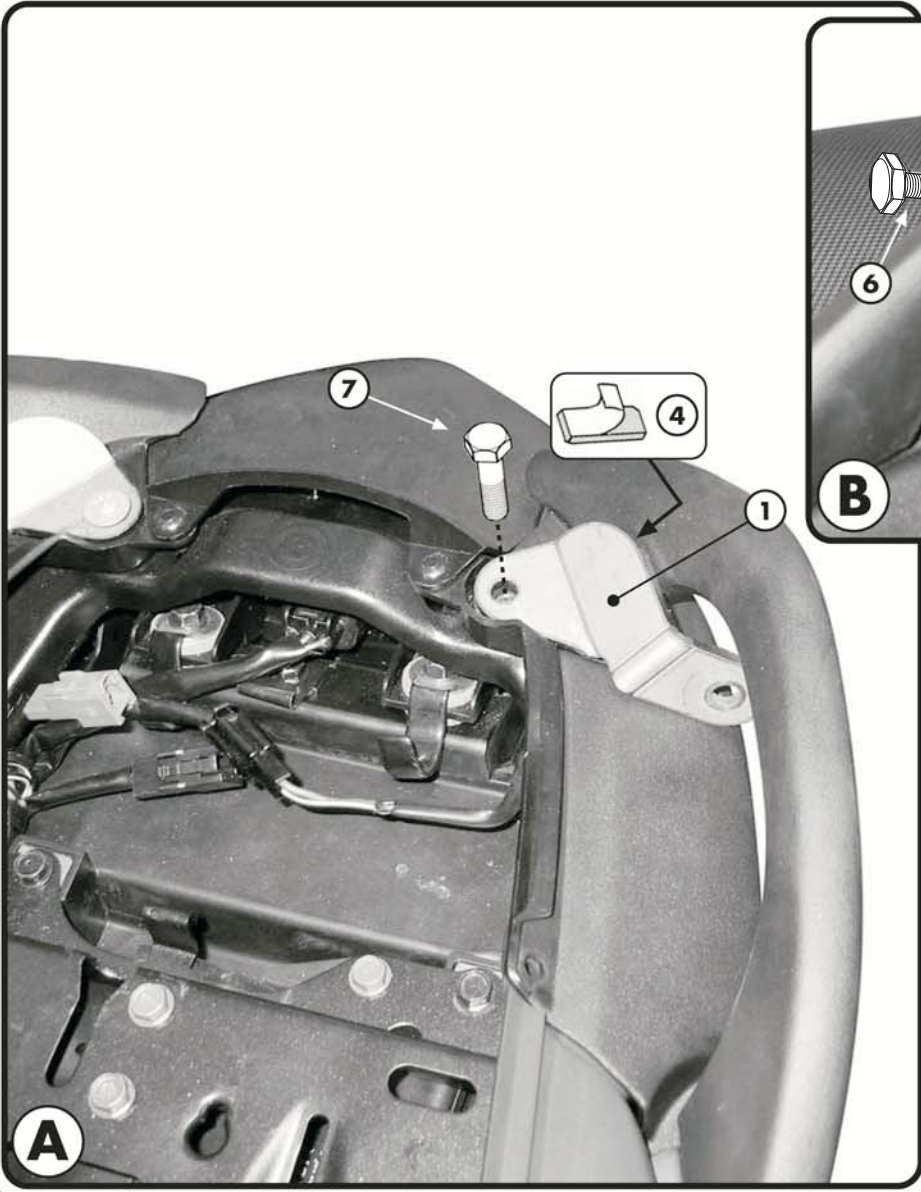

**ATTENZIONE**  
PESO MASSIMO SOPPORTABILE 10Kg.

**WARNING**  
MAX. LOADING OF THE CARRIER  
10Kg.(21lbs)

**ATTENTION**  
CHARGE MAXIMALE 10Kg.

**ACHTUNG**  
MAXIMALE BELASTUNG 10Kg.

**¡ATENCIÓN!**  
CARGA MÁXIMA AUTORIZADA 10Kg.

MONORACK SPECIFICO - SPECIFIC MONORACK  
MONORACK SPECIFIQUE - SPEZIFISCHES MONORACK - MONORACK ESPECÍFICO

# KAWASAKI VERSYS 06/08

## 650cc

ISTRUZIONI DI MONTAGGIO - MOUNTING INSTRUCTIONS  
INSTRUCTIONS DE MONTAGE - BAUANLEITUNG - INSTRUCCIONES DE MONTAJE

7

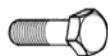

**VITE TE M8x30mm**  
Flangiate Nere  
SCREW M8x30mm  
VIS M8x30mm  
SCHRAUBE M8x30mm  
TORNILLO M8x30mm

**Q.TY n.2**

8



**DADO A.B. M8**  
Flangiate Neri  
BOLT M8  
ECROU M8  
MUTTER M8  
TUERCA M8

**Q.TY n.4**

9



**DISTANZIALE Ø18x14mm**  
Ribassato Ø13x9mm  
foro Ø8,5mm V526  
SPACER  
ENTRETOISE  
DISTANZSTUECK  
DISTANCIADOR

**Q.TY n. 2**

10



**COPRIVITE Ø8mm**  
Z801  
SCREW CAP  
CACHE VIS  
STOPSSCHRAUBE  
TAPA TORNILLO

**Q.TY n.2**

11

**COMPONENTI ORIGINALI**  
ORIGINAL PARTS  
PARTES ORIGINALES  
ORIGINAL BAUTEILE  
COMPONENTES ORIGINALES

**Q.TY n.-**

12

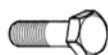

**VITE TE M8x45mm**  
Flangiate Nere  
SCREW M8x45mm  
VIS M8x45mm  
SCHRAUBE M8x45mm  
TORNILLO M8x45mm

**Q.TY n.2**

13

**PARTICOLARI INCLUSI NEL  
KIT VITERIA DELLA PIASTRA**  
COMPONENTS INCLUDED IN  
THE FITTING KIT OF THE PLATE  
PIÈCES INCLUES DANS LE KIT  
DE VIS DE LA PLATINE  
DIE EINZELNEN TEILE SIND BEI  
MONTAGEKIT DER PLATTE  
ENTHALTEN  
DESPIECES INCLUIDOS EN EL  
KIT DE ANCLAJES DE LA  
PARRILLA

**Q.TY n.-**

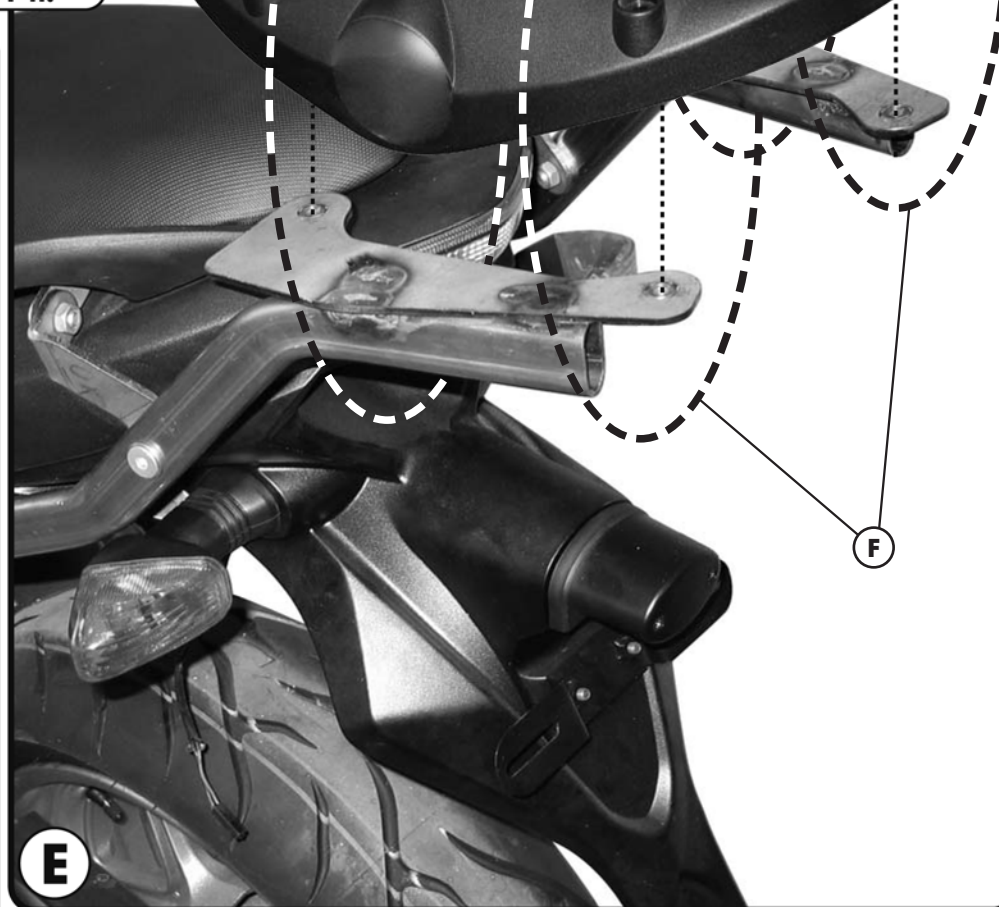

MONORACK SPECIFICO - SPECIFIC MONORACK  
 MONORACK SPECIFIQUE - SPEZIFISCHES MONORACK - MONORACK ESPECÉFICO

# KAWASAKI VERSYS 06/08

## 650cc

ISTRUZIONI DI MONTAGGIO - MOUNTING INSTRUCTIONS  
 INSTRUCTIONS DE MONTAGE - BAUANLEITUNG - INSTRUCCIONES DE MONTAJE

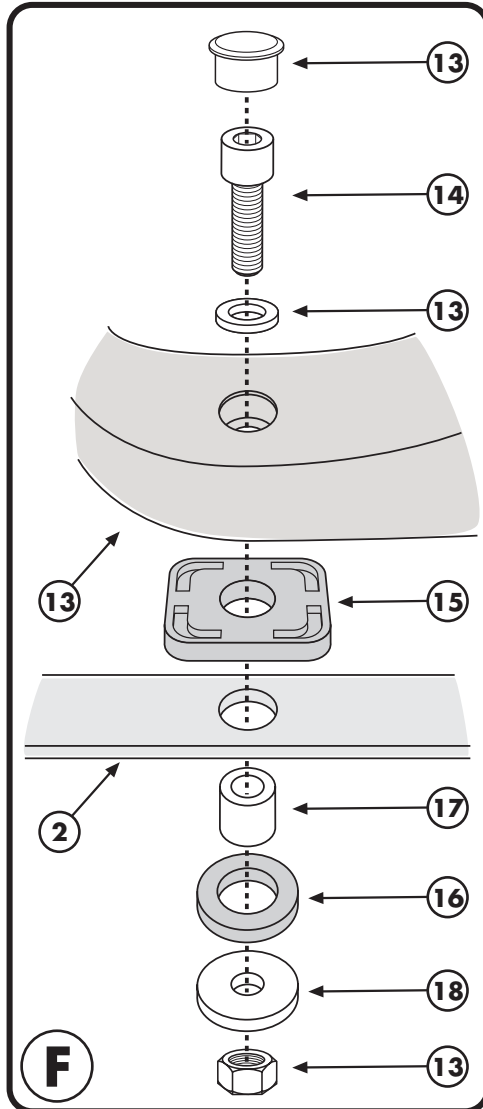

**14**



**VITE TCEI M6x35mm**  
 SCREW  
 VIS  
 SCHRAUBE  
 TORNILLO

**Q.TY n.4**

**15**

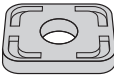

**GOMMINO**  
 Z1822  
 RUBBER  
 CAOUTCHOUC  
 GUMMI  
 GOMA

**Q.TY n.4**

**16**



**RONDELLA IN GOMMA**  
 Z1823  
 RUBBER WASHER  
 RONDELLE EN GOMME  
 GUMMISCHEIBE  
 ARANDELA DE GOMA

**Q.TY n.4**

**17**



**DISTANZIALE f11x11mm**  
 foro f6,5mm  
 V687  
 SPACER  
 ENTRETISE  
 DISTANZSTUECK  
 DISTANCIADOR

**Q.TY n. 4**

**18**



**RONDELLA f6x20mm**  
 WASHER  
 RONDELLE  
 SCHEIBE  
 ARANDELA

**Q.TY n.4**

MONORACK SPECIFICO - SPECIFIC MONORACK  
MONORACK SPECIFIQUE - SPEZIFISCHES MONORACK - MONORACK ESPECÍFICO

**KAWASAKI VERSYS 06/08**  
**650cc**

ISTRUZIONI DI MONTAGGIO - MOUNTING INSTRUCTIONS  
INSTRUCTIONS DE MONTAGE - BAUANLEITUNG - INSTRUCCIONES DE MONTAJE

## I ISTRUZIONI DI MONTAGGIO

1. MONTARE I SUPPORTI N°1, FOTOGRAFIA A; APPLICARE LA MUOSSE ADESIVA, PARTICOLARE N°4, COME INDICATO IN FOTOGRAFIA A;
2. MONTARE IL SUPPORTO N°3 COME INDICATO IN FOTOGRAFIA B;
3. MONTARE IL SUPPORTO MONORACK, PARTICOLARE N°2, COME INDICATO NELLE FOTOGRAFIE C E D;
4. FISSARE LA PIASTRA PORTAVALIGIA (NON INCLUSA) COME ILLUSTRATO IN FOTOGRAFIA E;
5. ULTIMARE IL MONTAGGIO CONTROLLANDO CHE TUTTE LE VITI SIANO SERRATE BENE.

## GB MOUNTING INSTRUCTIONS

1. MOUNT THE SUPPORTS N° 1, PICTURE A; STICK THE PROTECTIVE RUBBER PAD, N° 4, AS SHOWN IN PICTURE A;
2. MOUNT THE SUPPORT N° 3 AS SHOWN IN PICTURE B;
3. MOUNT THE MONORACK, PART N° 2, AS SHOWN IN THE PICTURES C AND D;
4. FIX THE TOP-CASE PLATE (NOT INCLUDED) AS SHOWN IN PICTURE E;
5. LASTLY CHECK THAT ALL SCREWS HAVE BEEN TIGHTENED.

## F INSTRUCTIONS DE MONTAGE

1. MONTER LE SUPPORT N.1, PHOTO A; APPLIQUER LA MOUSSE AUTOCOLLANTE, DETAIL N.4, COMME INDIQUE EN PHOTO A;
2. MONTER LE SUPPORT N.3 COMME INDIQUE EN PHOTO B;
3. MONTER LE MONORACK, DETAIL N.2, COMME INDIQUE PAR LES PHOTOS C ET D;
4. FIXER LA PLATINE PORTE VALISE (PAS INCLUSE) COMME INDIQUE EN PHOTO E;
5. TERMINER LE MONTAGE EN CONTROLANT LE BON SERRAGE DE TOUTES LES VIS.

## D BAUANLEITUNG

1. MONTIEREN SIE DIE HALTERUNGEN NR. 1, BILD A; BEFESTIGEN SIE DIE SCHUTZGUMMI N° 4, WIE IM BILD A BESCHRIEBEN;
2. MONTIEREN SIE DIE HALTERUNG NR. 3 WIE IM BILD B BESCHRIEBEN;
3. MONTIEREN SIE DIE MONORACK ARME, TEIL NR. 2, WIE IN DEN BILDERN C UND D BESCHRIEBEN;
4. BEFESTIGEN SIE DIE PLATTE (NICHT VORHANDEN) WIE IM BILD E BESCHRIEBEN;
5. ZULETZT ÜBERPRÜFEN SIE, DASS ALLE SCHRAUBEN FESTGEZOGEN WURDEN.

## ES

## INSTRUCCIONES DE MONTAJE

1. MONTAR EL SOPORTE N° 1, IMAGEN A, APLICAR EL PEGAMENTO, ARTICULO N°4, TAL Y COMO SE INDICA EN LA IMAGEN A.
2. MONTAR EL SOPORTE N° 3 TAL Y COMO SE INDICA EN LA IMAGEN B;
3. MONTAR EL SOPORTE MONORACK, ARTICULO N°2, TAL Y COMO SE INDICA EN LA IMAGEN C Y D.
4. FIJAR LA PARRILLA PORTAEQUIPAJES (NO INCLUIDA) TAL Y COMO SE ILUSTRAN EN LA FOTOGRAFIA E;
5. FINALIZAR EL MONTAJE ASEGURANDOSE QUE TODOS LOS TRONILLOS HAN SIDO APRETADOS CORRECTAMENTE.